



**ML GLASS
FOR SUSTAINABLE
ARCHITECTURE
& BUILDINGS**





ML GLASS

ML Glass is a line of single or multifunctional glass products: with the option of changing the translucency mode, with an integrated heating and/or photovoltaic layer, with very good thermal insulation and high sound absorption. Smart Glass products are intended for use in sustainable architecture and transport, in modern interiors and in energy-efficient buildings.

**NEW
QUANTUM
ERA**

**HEATING
GLASS**

**DISPLAY
GLASS**

**VARIABLE
TRANSLUCENCY
GLASS**

E-DISPLAY

**GLASS
HEATER**

**GLASS
WINDOW
SILL**

TECHNOLOGY COMPANY

Glass is a very popular building material with a wide range of applications. ML System offers many production and processing possibilities of this unique material: both initial and advanced processing of glass panes - cutting out any shape, outline, holes, as well as precise edge finishing and effective engraving. The offer also includes glazing units with a heating function, with variable transparency, capable of producing electricity from insolation. Modern technological lines in which the ML System machine park is equipped guarantee precise and aesthetic execution of each individual project.

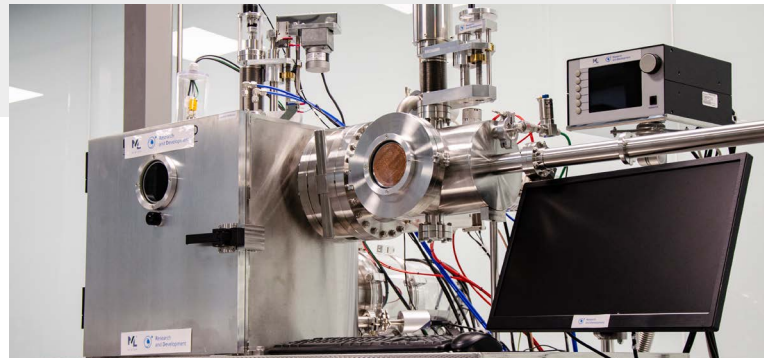
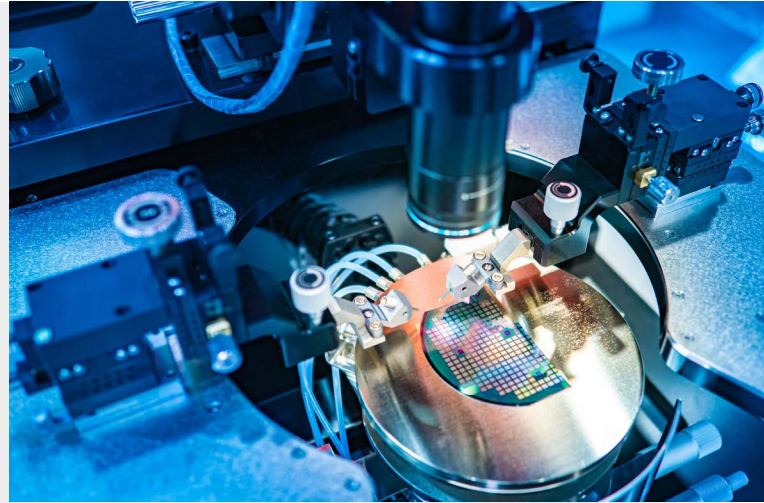

ADVANTAGES



Quantum dots layer
to generate free
electricity



**Natural
materials**

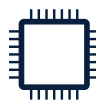

**System
drivers**



**Several
steps of
translucency**



Layer of nanotubes
acting as optical
waveguides for a
selected range of
light



NEW QUANTUM ERA

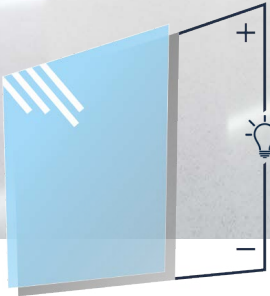

Transparent glass that generates electricity. The quantum revolution in global construction.



Payback time
5 years



Possibility of size
personalization



Scan the code
and check ML Glass
products



QUANTUM REVOLUTION IN GLOBAL CONSTRUCTION INDUSTRY

The ML System innovative glass with quantum dots layer is the first and only solution on a global scale which, thanks to the use of a coating consisting of quantum dots on the glass, allows to generate free electricity from the sun, while limiting harmful UV and IR radiation. Glass with quantum coating has very good parameters of light transmission, while maintaining a high thermal insulation coefficient. This innovative solution reduces overheating of rooms, as well as the effect of the so-called urban heat island (UHI). It is a breakthrough in the energy balance of cities.

Wide application possibilities

- Building façades and curtain walls
- Roof glazing (skylights)
- Glass railings, conservatories
- Glass of mobile devices
- Unusual projects, e.g. glass bridges, glass stairs, glass floors
- Special use (medicine, military, aviation)



TYPE III
ENVIRONMENTAL
DECLARATION

Max dimensions	1000 x 2000 mm
Efficiency	from 30W/m ²
QDSC	Active
Thermal insulation	U _g from 0,4 W/m ² K
Energy insulation	g from 0,22
Light transmittance	LT up to 85% (for coated VSG)
Additional functions	<ul style="list-style-type: none"> - weather resistance - resistance to degradation - resistance to mechanical damage - safety of use - tested with fire resistant glass in IGU for EI30 (according to EN 13501)



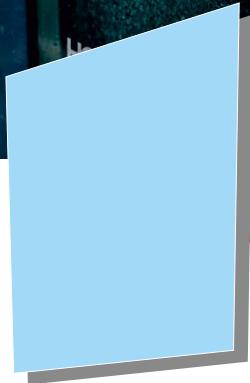

1-chamber and 2-chamber glazing with heating function, equipped with a controller, allows you to easily control the temperature inside the room



Possibility of size personalization



Scan the code and check ML Glass products

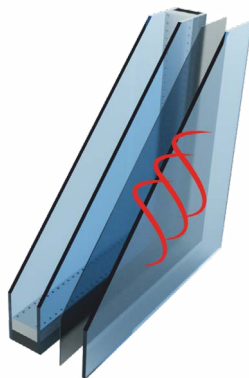

Ug-1,0W/m²K

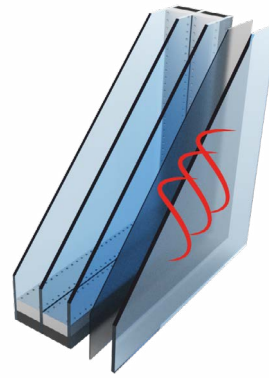

Ug-0,5W/m²K

INTELLIGENT HEATING GLASS

Design and execution

Intelligent heating glass is a modern thermal solution that allows you to eliminate the traditional heating system. It ensures the transparency of the glass and the comfort of warm inside the buildings. The offer includes a wide range of colors and backlighting as well as glass sizes.

Intelligent warmth control

The integrated control system allows you to easily control the temperature. Regardless of the climate, it guarantees high heating efficiency. Depending on the heating power and thermal insulation, the product is available in several variants.

Technical parameters

	2500		700
	Integrated control	External control	
Min. thickness	29 mm	21 mm	21 mm
Max. thickness	100 mm		
Max. dimensions*	2200 x 1800 mm		
Temperature control system	integrated	external	external
Max. Temperature	70°C limited electronically		55°C
Max. Heating speed	10°C/min		4°C/min
Max. Heating power	2500 W/m ²		700 W/m ²
Power supply	230 V/50 Hz		
Protection degree	IP 65		
Max. Light transmission	78 %		
Additional functions	<ul style="list-style-type: none">• overheating protection• maintaining the set temperature• LED display**		

EN 60529; EN 60335-2; EN 12150-1+A1:2019-06; EN ISO 12543-2

* larger dimensions require an analysis of technical production possibilities

** applies to the 2500 model

WE ARE CHANGING THE WORLD FOR FUTURE GENERATIONS



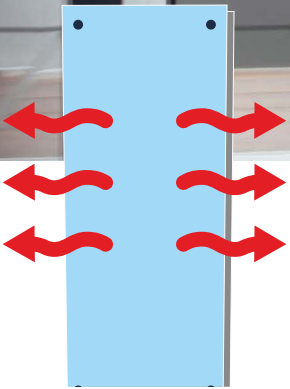

An innovative heater with a glass heating surface and electronic control.

Glass heater available in colors:



Marble



Concrete



Wood



Corten



Red brick



Anthracite brick



Granite

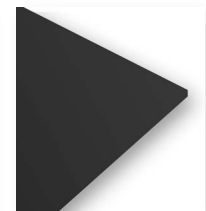

Black



Possibility of
color and pattern
personalization



Scan the code
and check ML Glass
products

Designs matching elevation/facade appearance

Design and execution

Glass heater is the combination of warmth comfort with an innovative design and the highest quality of the workmanship. It is designed for people who want to equip their interior with an unconventional device and, above all, ensure optimal thermal conditions.

Intelligent thermal comfort

High performance together with unique hidden touch, electronic control ensure comfort of use. The maximum temperature that the user can set for the device is 70°C and is electronically limited, which provides additional safety of use.

Easy assembly system

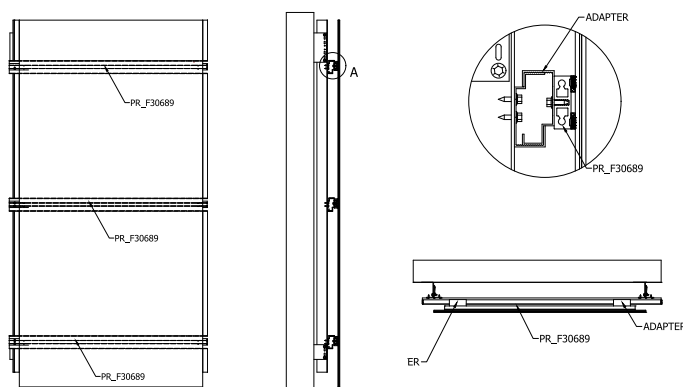

Technical parameters

Dimensions*	600 x 1200 mm
Max heating power	2500 W/m ²
Power supply	230 V/50 Hz, integrated power cord
Max. radiator temperature	70°C limited electronically
Heating speed	up to 10°C/min
IP Protection degree	IP 65
Weight	17 kg
Control system	Electronic, touch
Additional functions	<ul style="list-style-type: none"> • overheating protection • maintaining the set temperature • LED display

EN 55014-1; EN 55014-2; EN 61000-3; EN 62233; EN 60335-1; EN 60335-2-30
Compliant with: RoHS, EMC, LVD

* larger dimensions require an analysis of technical production possibilities



discreetly placed controller

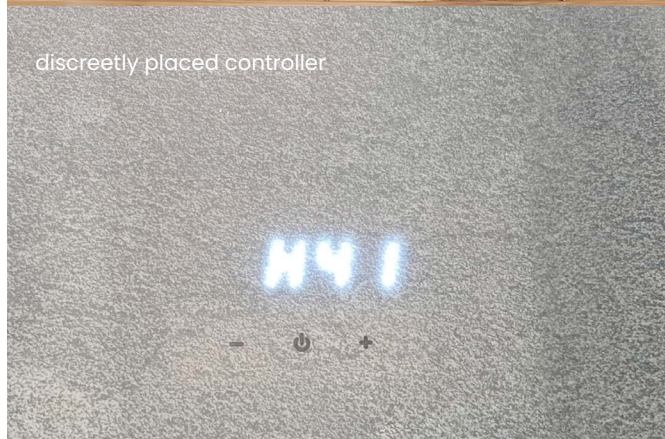



The glass heating sill helps to maintain proper air circulation in the interiors and serves as an inductive charger.

Sill glass available in colors:



Possibility of color and pattern personalization



Scan the code and check ML Glass products



Marble

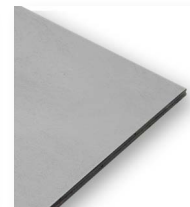

Concrete

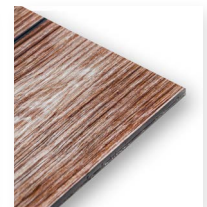

Wood

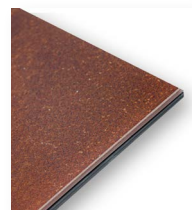

Corten



Granite

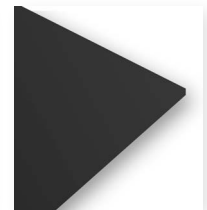

Black

Designs matching elevation/facade appearance

GLASS HEATING WINDOW SILL

Design and execution

Glass heating window sill is an innovative product with a heating function, the possibility of wireless charging, and additionally helps to maintain the proper air circulation in interiors. Regardless of its usability, the window sill can emphasize the character of a given room, satisfying even the most sophisticated tastes.



discreetly placed controller

Technical parameters

Dimensions*:	1500x300 mm	950x300 mm
Power consumption:	max 1050 W	max 750 W
Additional functions:	<ul style="list-style-type: none">• touch control• display showing the current temperature of the radiator integrated with the indicator of its operation status• adjustable temperature in the range of 20-70°C	
Led backlight:	<ul style="list-style-type: none">• heating - red,• inductive charging - blue• heating and charging (red and blue color displayed simultaneously)	
Parameters	<ul style="list-style-type: none">• compliance with the Qi standard• possibility of charging in 4 modes depending on the power used by the receiver - 5 W / 7.5 W / 10 W and 15 W	



*the table shows exemplary parameters, any dimension can be made
EN 60529; EN 60335-2; EN12150-1+A1:2019-06; EN ISO 12543-2:2011



CLOSE SHADE OPEN



Glass with variable translucency that can be switched into OPEN, SHADE and CLOSE modes
Glazing unit with variable transparency and heating function



Possibility of size personalization



Scan the code and check ML Glass products

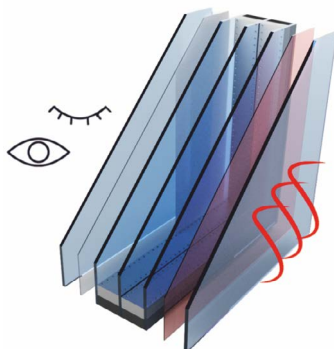

CLOSE
0% transparency

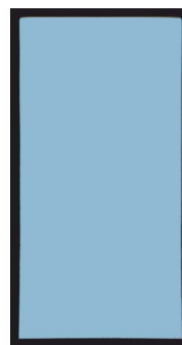

SHADE
50% transparency

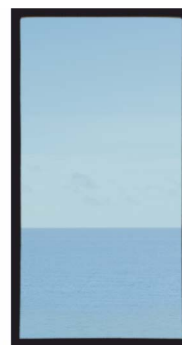

OPEN
100% transparency

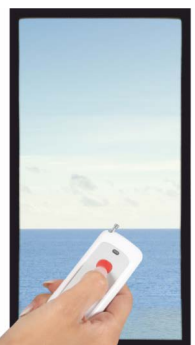

VARIABLE TRANSLUCENCY GLASS WITH ADDITIONAL HEATING FUNCTION

Design and execution

Glass with variable transparency a solution that enables individual adaptation of the room in terms of visibility tailored to the user's needs. By choosing one of the three options, it is possible to swap space from open to semi-private or private (100%, 50%, 0% translucency).

Glass with variable transparency with heating is a combination of thermal comfort with intimacy. Glass with variable transparency with heating is a glass that can be switched to OPEN, SHADE, or CLOSE mode and function as a heater at the same time. The Glass with variable translucency with heating glazing set can replace the traditional heating system inside the room. The integrated control system makes it easy to control the temperature. The glass is available in several options, depending on the power and thermal insulation of the selected package



Models	Glass 2500		Glass 700	Variable translucency glass	
				Laminate	Fusion
Temperature control system	integrated	external	external	N/D	N/D
Min. thickness	46 mm	38 mm	38 mm	9 mm	21 mm
Max thickness	100 mm				
Max. Dimensions*	2200x1800				
Max. temperature	70°C limited electronically		55°C	N/D	N/D
Max. heating speed	10°C/min		4°C/min	N/D	N/D
Max. heating power	2500 W/m ²		700 W/m ²	N/D	N/D
Max. power consumption of the variable translucency function	<ul style="list-style-type: none"> in the translucency mode 5 W/m² non-translucent mode 0 W/m² 				
Lifetime	<ul style="list-style-type: none"> in the translucent mode 80 000h in the non-translucent mode without limits 				
Light transmission	<ul style="list-style-type: none"> ultraviolet ~1% infrared: ~40% in the non-translucent mode absorbs about 60% of the infrared IR radiation thus reducing heating of the rooms 				
Protection degree	IP 65				
Power supply	230 V/50 Hz				
Max. light transmittance in opaque/translucent mode	28/87 %				
Additional functions	<ul style="list-style-type: none"> overheating protection maintenance of the set temperature LED display** the possibility of personalizing the color, dimensions, printing in the non-transparent mode 0 W/m² 			<ul style="list-style-type: none"> the possibility of personalizing the color, dimensions, printing 	

EN 60529; EN 603350-2; EN 12150-1+A1:2019-06; EN ISO 12543-2:2011

* larger dimensions require analysis of technical production possibilities

** applies to the Glass 2500 model



Display Glass is a transparent display with the ability to display content and image. Perfect informative-communicative solution for use in all types of public transport, such as trains, trams, buses, etc. The display has high visibility even in high light conditions, as well as a wide viewing angle. Display Glass is resistant to external factors, such as high or low temperatures or humidity. The display has a wide range of possibilities to implement various messages, content, video, and graphics.

Display type	Matrix	Segmented	OLED
Display diagonal	6,7"	4,2"	6"
Resolution	160x60 px	40 predefined segments	1080x2160 px
Communication interface	USB, SPI	USB, SPI	HDMI
External dimensions	224x90x2,2 mm	117x48 mm	137x69 mm
Active area	160x60 mm	105x25 mm	136x68 mm
View angle	2 x 179° (two sides - the base is transparent)	2 x 179° (two sides - the base is transparent)	160°
Supply voltage	12 V DC	12 V DC	5 V DC
Power input	max 36 W	max 3 W	3 W

E-DISPLAY

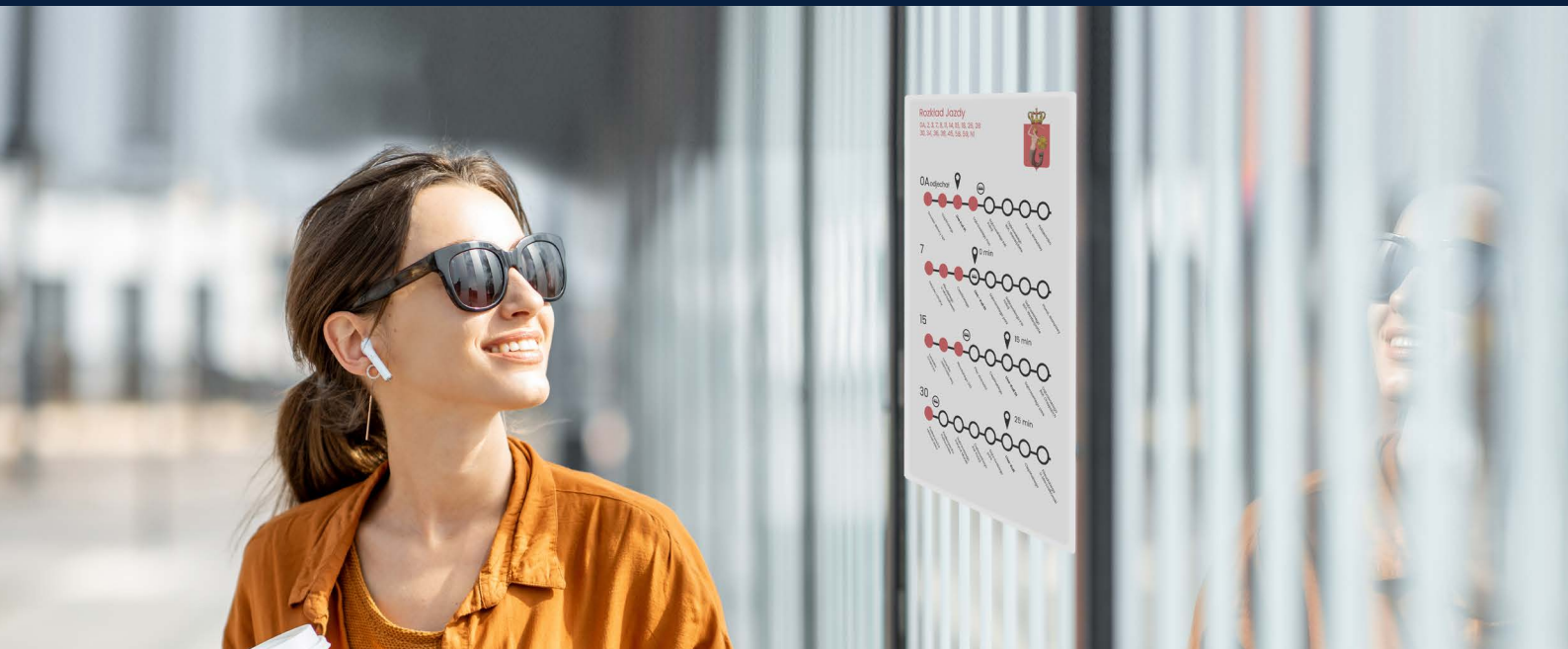

E-Display is an electronic variable message display. The device has a wide range of applications, thanks to complete flexibility in displaying content and graphics. E-Display can perform both an information function in places of public transport: stops, platforms, stations, and airports, by displaying timetables or flight plans, and also an advertising function, by displaying various types of advertisements, promotions, and image messages. The display has many convenient functionalities, such as remote content update, the ability to control using a gesture sensor and a touch button, the ability to connect to external city servers, the ability to be powered by a PV installation, fast refreshing time (about 2s), as well as remote communication via the network local, USB and SPI.



Model	Color	Monochromatic
Display size	31.2 cal	
Display resolution	1280 x 720 px	2560 x 1440 px
Communication interface	USB, SPI	
Active area	691,2 x 388,8 mm	691,2 x 388,8 mm
View angle	180°	
Bit depth	1-4 bit	
Shades of grey	2-16	
File format	BMP	
Power voltage	12 V DC	
Power consumption*	14 W	9,6 W





2D Glass has a passive quantum coating which, unlike active coatings, does not generate electricity from insolation. 2D Glass works well in architectural designs in places where the use of energy-active glass is limited or excluded for economic reasons.



Possibility of size personalization



Scan the code and check ML Glass products

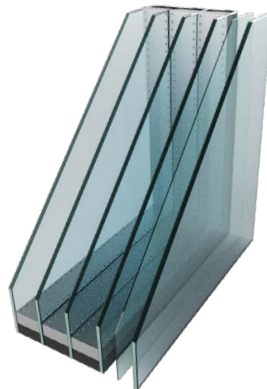

3-chamber combination with a selective coating

Innovative IGU

2D Glass is an innovative glazing unit based on the technology of quantum coatings, used as a selective coating (energy inactive). In relation to the glass panes used so far in the glass industry, 2D Glass improves the parameters of light transmission, thermal and energy insulation, which are a response to the requirements of the current regulations regarding the insulation of windows and façade glazing. An additional advantage is also a significant improvement in mechanical parameters and resistance to degradation and aging under the influence of weather conditions. An important feature of the new product is also the reduction of the lens effect, which will have a positive impact on the environment, especially in large cities.

Technical parameters

Max. dimensions	2000 x 4000 mm
Thermal insulation	Ug from 0,5 W/ m ² K
Solar factor	g=0,22
Light transmittance	Lt = min. 56%
Selectivity	S=2.5
Additional functions	High durability of the coatings used, absorption of the IR range Technical parameters





ML System HQ, Zaczernie, Poland

ML System S. A.

ML System S.A. – Polish highly specialized technology company with its own production plant and strong R&D Center equipped with world-class laboratory equipment. The company, which has been operating on the market over for dozen years (registration date in 2006), specializes in traditional and innovative photovoltaic solutions, of which it is both a producer and a distributor. It has been listed on the Warsaw Stock Exchange since 2018.

ML System products are an attractive alternative to traditional building materials. The company is a leader in its industry on the Polish market. Moreover, according to the Global Building Integrated Photovoltaic Skylights Market 2021-2027 report, the company is one of the key global producers

ML System is a manufacturer and supplier of complete technologies for use in the building, including assembly, control and building management systems.



ML SYSTEM KEY POINTS

-  Polish producer of BIPV modules and BIPV systems with an established position on the Polish market and a key player overseas.
-  **First and only of the world manufacturer of Glass with quantum coating** - energy-active glass
-  Very well equipped **Photovoltaic Research and Development Center**
-  **Technological advantage** thanks to high investment expenditures
-  **Product diversification**, industry diversification and geographic diversification
-  The leader of innovative solutions with **16 granted patents and 6 patents pending**
-  **BIPV modules manufactured by ML System have Environmental Product Declaration (EPD) to comply with the requirements and environmental standards required in sustainable construction**

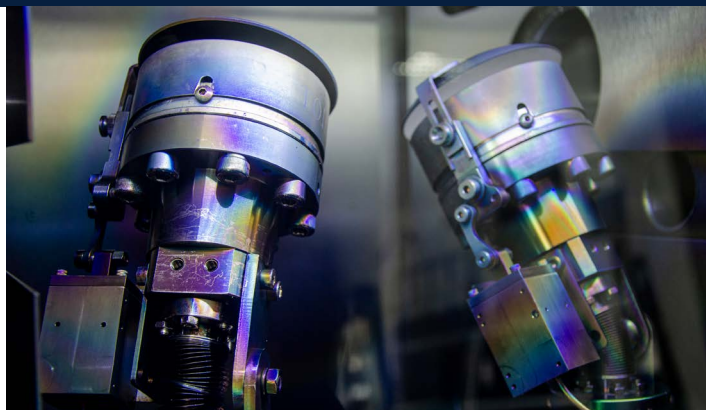

R&D Photovoltaic Center



R&D Photovoltaic Center

Dynamic increase in production capacity and efficiency

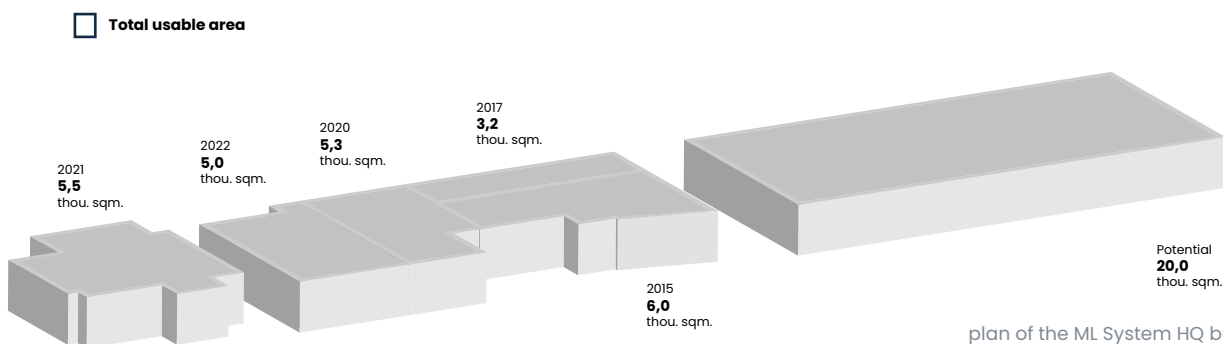
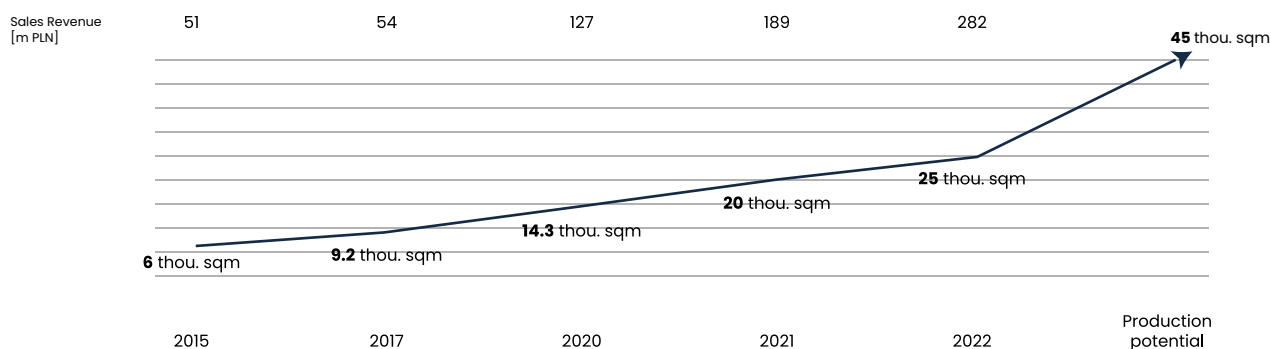

plan of the ML System HQ buildings
data valid at 01.03.2023



1

THE FIRST GLOBAL ATOMIC LAYER DEPOSITION TECHNOLOGY IN BIPV

REGIONAL CONTACTS

Export Sales Director
Jan Strzalkowski

mobile: +48 512 224 624
e-mail:
jan.strzalkowski@mlsystem.pl

DACH & Baltic Countries
Karol Kotowicz

mobile: +48 530 311 466
e-mail:
karol.kotowicz@mlsystem.pl

Nordic Countries
Piotr Sternik

mobile: +47 486 85 816
e-mail:
piotr.sternik@mlsystem.pl

Eastern & Southern Europe
Paweł Koniewicz

mobile: +48 570 604 260
e-mail:
pawel.koniewicz@mlsystemplus.pl

GENERAL CONTACT

e-mail: **international@mlsystem.pl**

HEADQUARTER OFFICE

ML System
Zaczermie 190 G, 36-062 Zaczermie

mobile: +48 17 77 88 266
e-mail: biuro@mlsystem.pl



www.facebook.com/MLSystemSA/



www.instagram.com/ml.system/



www.youtube.com/user/mlsystempl/



www.pl.linkedin.com/company/ml-system-sa



mlsystem.pl

